

Loop and earth Ohmmeter

C.A 6456



ENGLISH

User's manual

 **CHAUVIN[®]
ARNOUX**
CHAUVIN ARNOUX GROUP

Meaning of the  symbol :

WARNING ! Consult the user manual before using the instrument.

Failure to follow or carry out the instructions in this user manual that are preceded by this symbol may result in personal injury or damage to the instrument and the installations.

 **Consult the user manual before using the instrument!**

Thank you for purchasing a **C.A 6456 loop and earth ohmmeter**.

To get the best service from this instrument :

- **read** carefully this user's manual,
- **respect** the safety precautions

PRECAUTIONS FOR USE

This instrument can be used on **category III installations at voltages not exceeding 550V with respect to earth**. Category III meets the reliability and availability requirements of uses on fixed industrial installations (cf. EN 61010-1 + A2).

- **Never use the C.A 6456 tester on installations having a potential greater than 550V with respect to earth.**
- **Check that none of the input terminals is connected and that the switch is set to OFF before opening the instrument.**
- Use connection accessories of which the overvoltage category and service voltage are greater than or equal to those of the measuring instrument (600V, cat. III). Use only accessories that comply with safety standards (EN 61010-031 and EN 61010-2-032).
- Do not immerse the C.A 6456 tester!
- Repairs and metrological verifications must be carried out by approved, qualified personnel.

WARRANTY

Unless otherwise stated, our warranty is valid for **twelve months (12 months)** following the date on which the equipment is made available (extract from our General Conditions of Sale, available on request).

SOMMAIRE

| | | |
|----------|---|-----------|
| 1 | PRESENTATION | 4 |
| 1.1 | Environmental conditions | 5 |
| 1.2 | Compliance with standards | 5 |
| 1.3 | Power supply | 5 |
| 2 | DESCRIPTION | 6 |
| 3 | GENERAL USE | 9 |
| 3.1 | Automatic checks | 9 |
| 3.2 | Instrument configuration (SET-UP) | 10 |
| 3.3 | Compensation of the leads | 11 |
| 3.4 | Recording measurement results (MEM) | 13 |
| 3.5 | Recalling recorded values (MR) | 13 |
| 3.6 | Erasing recorded values | 14 |
| 3.7 | Printing measurement results (PRINT) | 15 |
| 3.8 | Printing recorded values (PRINT MEM) | 15 |
| 4 | MEASUREMENTS | 16 |
| 4.1 | Voltage measurement | 16 |
| 4.2 | 2P and 3P earth measurement | 21 |
| 4.3 | Earth measurement in live condition (REARTH) | 25 |
| 4.4 | 3-wire loop measurement (Z LOOP) | 32 |
| 4.5 | 2-wire loop measurement (Z LINE) | 35 |
| 4.6 | Current measurement () | 37 |
| 5 | GLOSSARY | 39 |
| 6 | MAINTENANCE | 40 |
| 6.1 | Replacing the batteries | 40 |
| 6.2 | Storage | 40 |
| 6.3 | Cleaning | 40 |
| 6.4 | Metrological verification | 40 |
| 6.5 | Warranty | 40 |
| 6.6 | Customer service | 40 |
| 6.7 | Repair | 40 |
| 7 | LIST OF CODED ERRORS | 41 |
| 8 | TO ORDER | 41 |

1. PRESENTATION

Portable instrument for testing and checking the safety of new and existing electrical installations (loop ohmmeter).

Measurement functions :- Voltage,

- Frequency,
- Test of protective conductor, PE,
- Earth resistance with 2 auxiliary rods (3P method)
- Coupling resistance (2P method)
- Loop impedance, with display of the resistive part and of the inductive part,
- Calculation of short-circuit currents,
- Current, with clamp,
- Selective earth resistance (with clamp).

Execution : - 8-way central switch and 7-key keypad.

Display : - Backlit 160-segment LCD display unit with two simultaneous digital displays, A1 and A2:

- 4 digits to display up to 4,000 measurement points,
- 3 decimal points for the different display ranges.

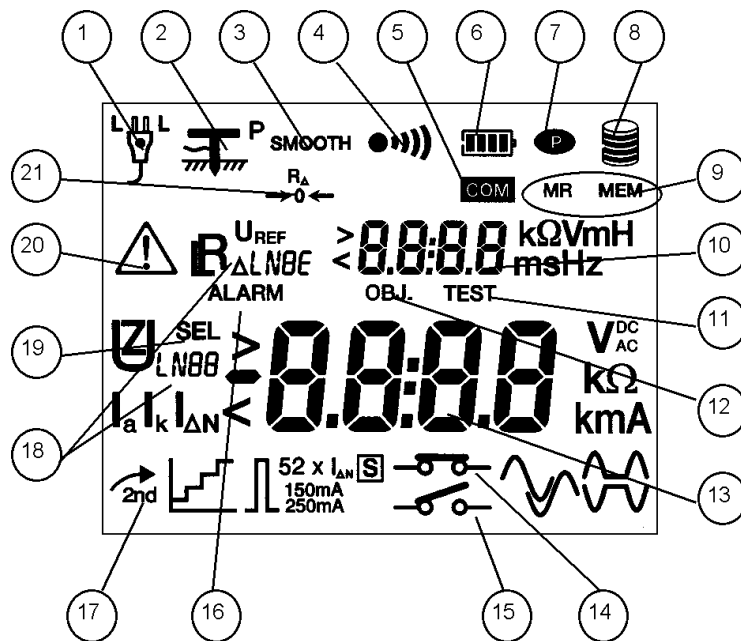

| | | | |
|----|---|----|---|
| 1 | position of the phase conductor | 12 | "object" number for storage |
| 2 | auxiliary earth rod detected | 13 | main display unit A1 |
| 3 | measurement smoothed for display | 14 | measurement without triggering of residual current differentials (RCD) (low power signal) |
| 4 | audible buzzer activated | 15 | measurement with triggering of RCD (full power level) |
| 5 | communication in progress (serial link) | 16 | alarm function activated or display of an alarm threshold |
| 6 | battery charge level | 17 | secondary function activated |
| 7 | Auto standby function deactivated | 18 | type of quantity displayed |
| 8 | level of memory use | 19 | selective measurement |
| 9 | reading/recording in memory | 20 | "WARNING" indicator (if it appears, refer to the manual) |
| 10 | secondary display unit A2 | 21 | compensation of measuring cables activated |
| 11 | "test" number for storage | | |

1.1 ENVIRONMENTAL CONDITIONS

| | |
|-----------------------|---|
| Temperature : | Service conditions: -10 to +55°C - storage and transport (without batteries): -40 to +70°C. |
| %RH (without cond.) : | Service conditions: 85% max. - storage and transport (without batteries): 90% max. |
| Tightness : | IP54 as per standard NF EN 60 529. |

1.2 COMPLIANCE WITH STANDARDS

1.2.1 GENERAL

The instrument complies with the following standards:

- EN 61010-1,
- NF EN 61557 : parts 1, 3, 5 and part 10,
- EN 60529.

1.2.2 SAFETY

The instrument complies with the requirements of standards EN 61010-1 and EN 61557, i.e. :

- service voltage: 550 V,
- measurement category: III with double insulation,
- level of pollution: 2.

1.2.3 ELECTROMAGNETIC COMPATIBILITY

The device is in conformity with standard IEC 61326-1:

- Emissions : Requirements on class B equipment.
- Immunity : Requirements on equipment used in discontinuous operation on industrial sites.

1.3 POWER SUPPLY

Power supply : 6 LR6 1.5V alkaline batteries; they can be replaced by rechargeable sealed batteries having a capacity of at least 1,800 mAh.

Battery life : 30 hours or approximately :

- 10,000 loop measurements or under voltage earth measurements
- 1,000 earth measurements (2P/3P) during 30 seconds
- 30,000 voltage or current measurements during 5 seconds.

2. DESCRIPTION

Preliminary remarks : Several types of action are possible on each key of the keypad, depending on whether the user presses the key briefly (short press, < 2s, validated by a beep) or at length (long press, > 2s, validated by a beep having a tone different from that of the beep emitted for a short press). In what follows, these different actions are symbolized as follows:





for a short press on the key in question

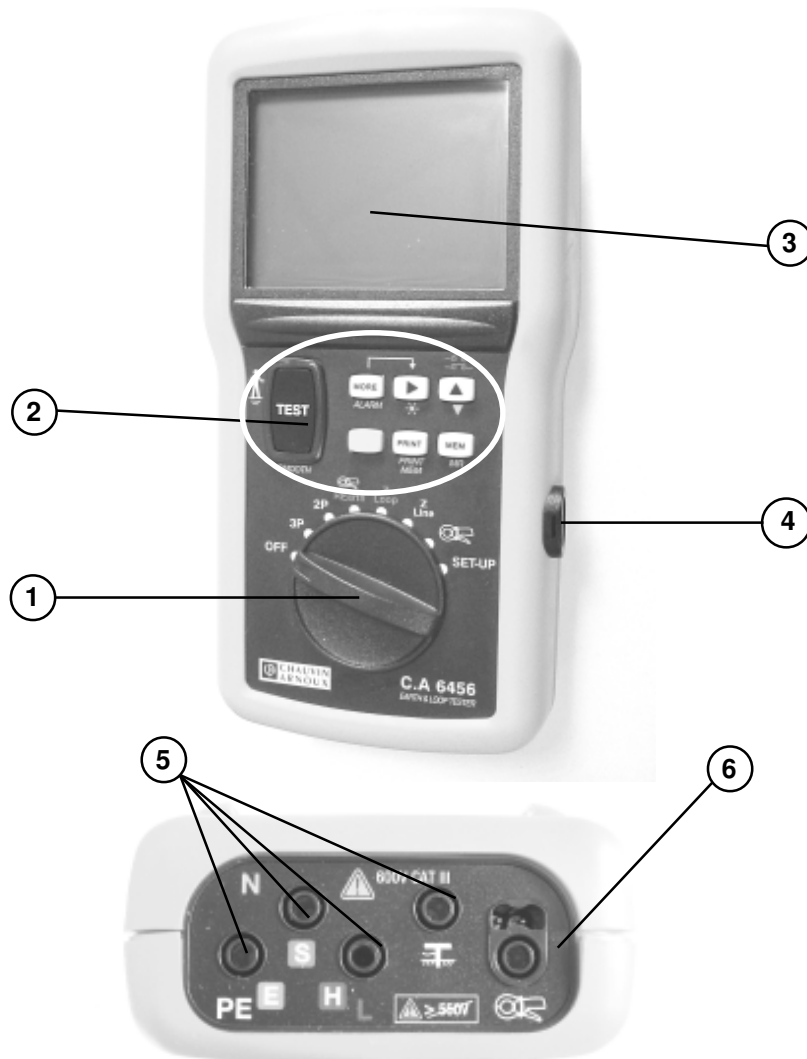

for a press > 2s on the key in question



1 8 WAY ROTARY SWITCH :



- OFF : instrument off
- 3P : earth measurement with 2 auxiliary rods
- 2P : AC or earth coupling resistance measurement
- REARTH /  : earth measurement in a live condition, with one auxiliary rod (selective earth if clamp connected)
- ZLOOP : loop impedance measurement with 3 wires (high or low current), between phase (L) and earth (PE)
- ZLINE : loop impedance measurement with 2 wires (high current only), between two phases or between phase and neutral
-  : current measurement
- SET-UP : configuration of the instrument

⚠ Set the switch to OFF when the instrument is not in use



2 7-KEY KEYPAD :

The functions of the various keys are as follows for all the settings of the switch EXCEPT the SET-UP position (see § 3.2).



Touche 2nd :

| | | |
|--|----|---|
|  + press on other key | => | access the secondary function of the key in question (written in yellow italics below each key) |
|  | => | display the current time and date as long as the key is kept pressed |

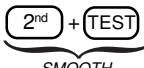

Touche TEST / SMOOTH :

| | | |
|--|----|--|
|  | => | start/stop a measurement (except for voltage and current measurements, which are made directly) and exit from the error mode |
|  | => | compensation of the measuring cables. |
|  <i>SMOOTH</i> | => | smooth the measurement (SMOOTH mode) |

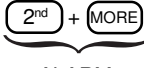
Touche MORE / ALARM :

| | | |
|--|----|--|
|  | => | display the measurements and/or complementary calculations of a function, possibly in association with the key  . |
|  ALARM | => | activate/deactivate the "alarm" function. |

Touche :

| | | |
|---|----|--|
|  | => | display the measurements and/or complementary calculations of a function, possibly in association with the key  . |
|---|----|--|

| | |
|--|---|
| | <p>=> select the memory block (OBJ) or line (TEST) for storage, retrieval on screen, or printing</p> |
| | <p>=> switch the backlighting of the display unit on/off</p> |

Key :

| | |
|--|---|
| | <p><i>with the switch set to ZLOOP and/or ZLINE:</i> => select the type of measurement ("tripping" or "non-tripping" mode)</p> |
| | <p>=> increment the value of the memory block (OBJ) or line (TEST)</p> <p>=> decrement the value of the memory block (OBJ) or line (TEST)</p> |

Key MEM / MR :

| | |
|--|--|
| | <p>=> store a measurement and all information linked to it.</p> |
| | <p>=> display stored measurements.</p> |

Key PRINT (PRINT MEM) :

| | |
|--|--|
| | <p>=> print the last measurement made</p> |
| | <p>=> print the selected part of the memory (part or all)</p> |

3 BACKLIT LCD DISPLAY UNIT

4 OPTICAL SERIAL COMMUNICATION INTERFACE

5 SAFETY INPUT TERMINALS , dia. 4mm, marked L, N, PE and P (terminal used for earth measurements in a live condition).

 **maximum voltage with respect to earth = 550 V**

6 MARKED SOCKET  **FOR THE CONNECTION OF A CURRENT CLAMP**

3. GENERAL USE

The measurements are made directly (voltage, frequency, and current if a clamp is connected) or by pressing the **TEST** key.

Voltage and/or frequency measurements are accessible in all "active" settings of the switch.

3.1 AUTOMATIC CHECKS

3.1.1 POSITION OF PHASE (MAINS SOCKET) CHECK

Upon connection, the instrument measures the voltages between conductors "L" and "N" (U_{LN}), between conductors "L" and "PE" (U_{LPE}), between conductors "N" and "PE" (U_{NPE}), and between the voltage probe - if a rod is connected to the terminal P - and conductor "PE".

The conductor that has the highest potential is taken to be the phase, designated by the letter "L" and identified by one of the following displays :



The measuring cable supplied with the instrument bears a white mark making it possible to determine the position of the phase on the mains socket.

The instrument also determines the frequency for any frequency $\geq 15.3\text{Hz}$ or DC

3.1.2 THE PROTECTIVE CONDUCTOR (PE) CHECK

In a loop measurement (ZLOOP) or an earth measurement in a live condition (REARTH), when the **TEST** key is pressed, the instrument first measures the potential difference U_c between the local earth (user's potential, via the **TEST** key) and the "PE" terminal.

If $U_c > U_L$, where U_L is the limit contact voltage ($U_L = 25$ or 50 V : see § 3.2 : SET-UP), the instrument indicates that it is impossible to make a measurement.

If a measurement is triggered, the instrument then monitors voltage U_{NPE} : if it increases by more than 20 V , the instrument stops the measurement and reports an error.

Pressing the **TEST** key again causes a return to voltage measurement mode.

 **In a loop measurement with 2 wires (ZLINE position), measurement of the potential between the earth and the "PE" conductor is omitted**

3.1.3 MEASUREMENT CONDITIONS CHECK

or a measurement to be authorized, in addition to the above two checks (determination of the position of the phase and of the voltage of the PE conductor), the following conditions must be satisfied:

- U_{LN} , U_{LPE} and $U_{NPE} < 550$ V,
- voltage: $f < 450$ Hz; current: $20\text{Hz} < f < 450$ Hz,
- loop or earth measurements in live condition: $f = 15,3$ to 65Hz,
- correct connection of the measuring cables (terminals connected and not interchanged).

Toute interdiction de mesure est accompagnée d'un message d'erreur (voir § 7), d'un bip d'erreur et de l'affichage clignotant du symbole \triangle .

3.2 INSTRUMENT CONFIGURATION (SET-UP)

=> Set the rotary switch to the SET-UP position.

The parameter or value configured is validated upon return to the "PUSH btn" screen.

Warning: if the switch is turned before the return to the "PUSH btn" screen, the modified data are lost.

The table below indicates the various parameters that can be configured and their programming sequence. Remark: generally, changes from "ON" to "OFF" and/or changes of the values of the parameters are effected using the \triangle/∇ key.

| Parameter | Presses | Values | Default values |
|---|--------------------------------------|---|-----------------|
| Time / Date | 2^{nd} + MEM successive | Euro (JJ/MM) US (MM/JJ) AAAA HH:MM | User adjustable |
| Type of power supply | 2^{nd} + | bAtt niMH | bAtt |
| Activate/deactivate automatic shutdown | 2^{nd} + 2x | on OFF | on |
| Automatic shutdown time | 2^{nd} + 3x | 01 to 59 mm | 5mn |
| Activate/deactivate the buzzer | 2^{nd} + \triangle/∇ | on OFF | on |
| Display the internal parameters of the instrument | successive | serial no. software version date of calibration LCD screen | |
| Number of measurements in "SMOOTH" mode | 2^{nd} + TEST | 2 to 5 | 3 |
| Printing of configuration | PRINT | | |
| Printer configuration (data rate) | 2^{nd} + PRINT | 300 to 9600 bauds | 9600 |
| Default configuration | TEST + TEST | see §3.2.1 | |

| Parameter | Presses | Values | Default values |
|---|--------------------------------|-----------------------------|------------------|
| Erase memory (totally or partially) | (MEM) | see §3.6 | |
| Reference voltage for the calculation of I_k | (MORE) x2 | see § 4.3.2 | voltage measured |
| Value of the low current I_{TEST} in "non-tripping" measurement | (MORE) x3 | 6.9 or 12 mA see § 4.2.2 | 12 mA |
| Threshold voltage U_L | (MORE) x4 | 25 or 50 V | 50 V |
| Alarms : | | | |
| Earth resistance threshold | (2 nd) + (MORE) | see § 4.2.2 | |
| Loop resistance or impedance threshold | (2 nd) + (MORE) x2 | see § 4.4.2 | |
| Measured current threshold | (2 nd) + (MORE) x3 | see § 4.6.2 | |

3.2.1 RESTORING THE DEFAULT CONFIGURATION

This can be used to restore the delivery configuration.
In SET- UP position:

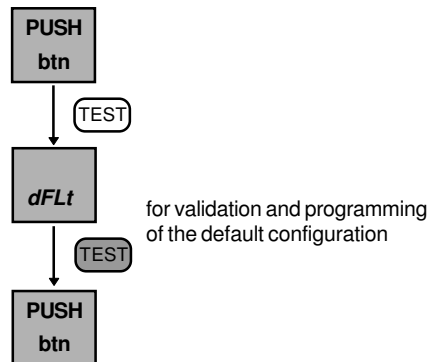

3.3 COMPENSATION OF THE LEADS

The leads must be compensated for measurements of low loop and earth resistance values, in order to make the measurements more accurate.

If a compensation already exists, the $\rightarrow R_L \leftarrow$ symbol is displayed. To view the compensation values, use the MORE and \blacktriangleright keys.

3.3.1 APPLYING A COMPENSATION

Set the switch to one the LOOP/RCD positions.

Connect one end of the three-conductor cord terminated by 3 leads to the device. Short-circuit the 3 leads. In the case of a mains outlet, connect the two earth pins with the earth pins with leads. Perform a long press on the TEST button.

During the measurement, the device displays "LEAd" and the  symbol, and the dashes blink.

At the end of the measurement, the  key is used to view the values of $R_{\Delta L}$, $R_{\Delta N}$ and $R_{\Delta PE}$.

3.3.2 WITHDRAW A COMPENSATION

Set the switch to one of the LOOP/RCD positions.

Connect nothing to the terminals, or leave the leads open.

Then perform a long press on the TEST button.

During the measurement, the device displays "LEAd" and the  symbol and the dashes blink.

To exit from compensation of the leads, perform a second long press on the TEST key.



If the compensation of the leads is effective, the  symbol is lit steadily.

If the compensation has not been performed, the symbol is not displayed and the compensation values are zero.

At the end of the measurement, the device reports that the result found is greater than 5 Ω and withdraws the compensation of the leads.

For exit from compensation of the leads, perform a second long press on the TEST key.

3.3.3 POSSIBLE ERROR MESSAGES

| Display - Indication | Remark - Possible cause |
|--|--|
|  Hz $U_{xy} > 2V$ | The voltage on the terminals exceeds 2 V. Check your connections. |
|  $> 5\Omega$ | The measured resistance of the leads is greater than 5 Ω . If this is not intentional, to withdraw the compensation, check your connections. |

3.4 RECORDING MEASUREMENT RESULTS (MEM)

⚠ IMPORTANT - Each measurement stored in the instrument is identified by 2 indices: an OBJ no. and a TEST no.; a given object (OBJ) generally contains several TEST nos.

For example: an OBJ no. can be used to locate an installation, and the TEST nos. identify the various measurements made on this installation.

At any time, the user can store the result of a measurement and all of the parameters associated with the measurement: date, time, type of measurement, measurement parameters, etc.

The location proposed by default is the first free memory location.

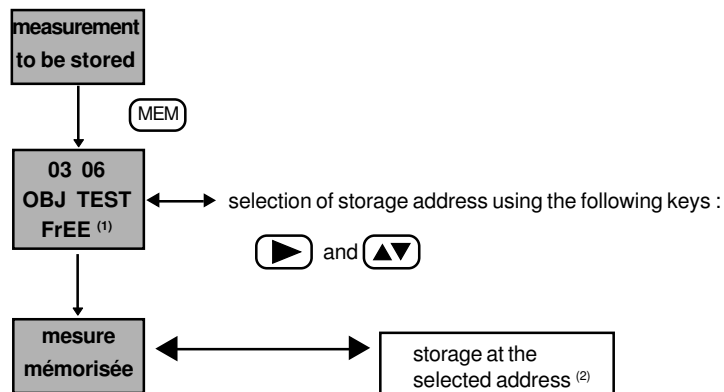

¹⁾ "FrEE": the selected memory location is free / "OCC": the selected memory location is occupied

²⁾ whether the location selected is occupied or not (previously recorded values are overwritten)

Note : Up to 100 measurements can be stored (e.g. 10 objects each having 10 tests, or any other combination).

3.5 RECALLING RECORDED VALUES (MR)



The group of measurements (OBJ) and the measurement (TEST) to be retrieved on the display unit are selected using the and keys.

3.6 ERASING RECORDED VALUES

The memory of the instrument can be erased, totally or partially, in the SET-UP rotary switch position:

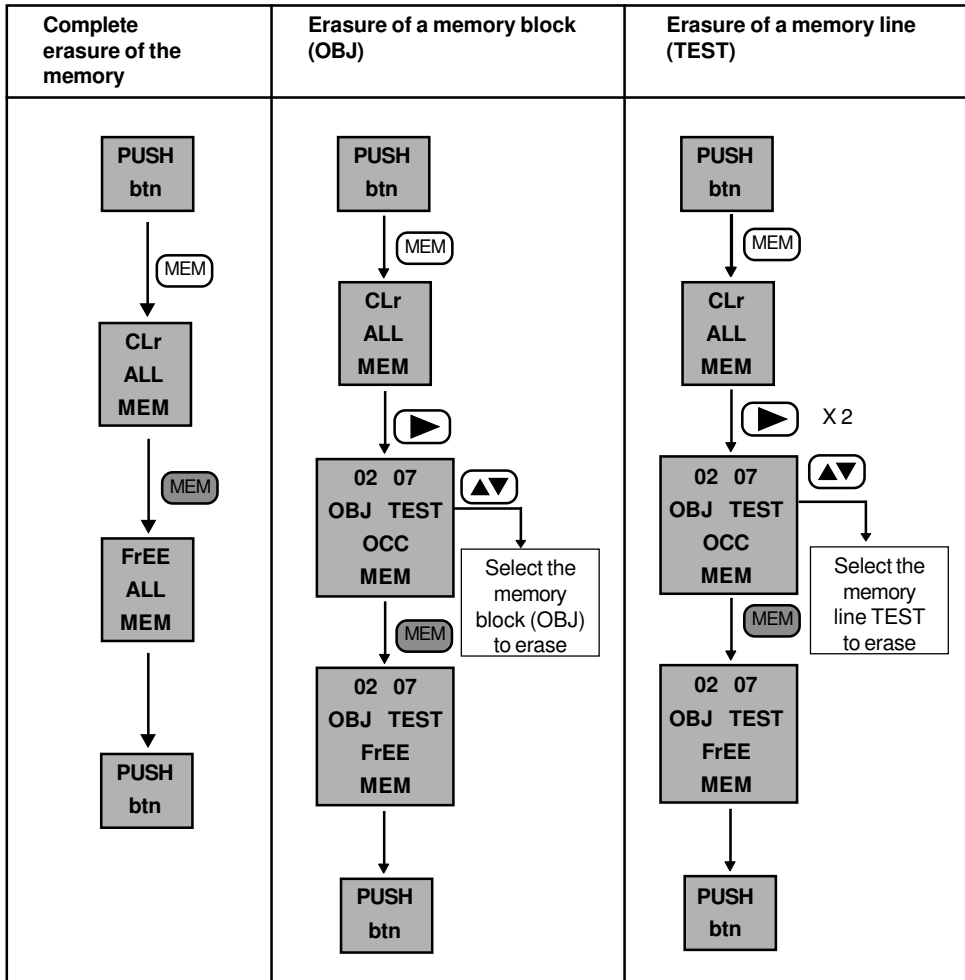

3.7 PRINTING MEASUREMENT RESULTS (PRINT)

PRINT : print the measurement made and all of the parameters attached to it.

Examples of printing tickets:

| | |
|---|--|
| <pre> EARTH current: no trip (30mA) Ra limit: 100 Ω Ra..... 154.2 Ω U L-N..... 227 V U L-PE.... 227 V U N-PE.... 0 V F..... 50.0Hz U S-PE.... 0 V </pre> | <pre> TIME 17:04 04.02.16 Instr. Nr. 100033 ----- LOOP MEM: 106 current: automatic range Z limit: 100 Ω U ref: 230 V Zs(L-PE)..... 154.7 Ω Ik..... 1.5 A Rs..... 154.7 Ω U L-N..... 227 V U L-PE.... 226 V U N-PE.... 0 V F..... 50.1Hz </pre> |
|---|--|

Remark : In the SET-UP position, pressing the PRINT key triggers printing of the configuration of the instrument.

3.8 PRINTING RECORDED VALUES (PRINT MEM)

Recorded values can be printed with the switch in any position except SET-UP or OFF.

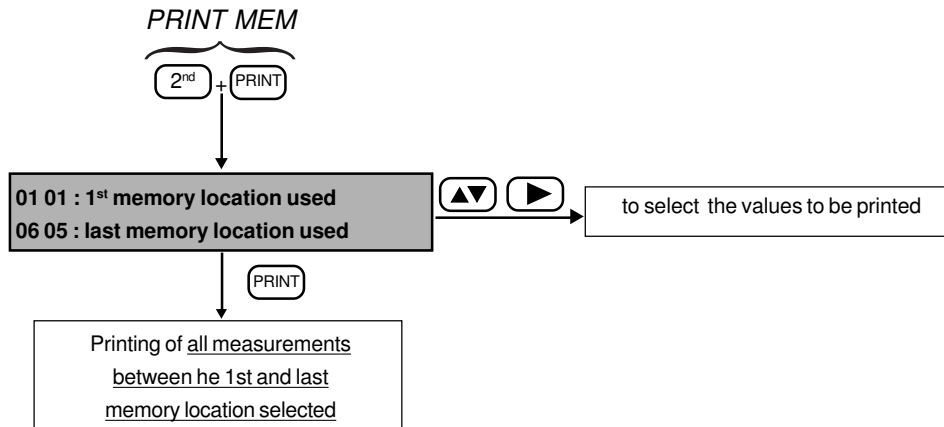

4. MEASUREMENTS

4.1 VOLTAGE MEASUREMENT

4.1.1 DESCRIPTION OF THE FUNCTION

Voltage measurement is accessible with the switch in any position except SET-UP or OFF.

4.1.2 PREPARATION OF THE MEASUREMENT (CONNECTION)

- => Switch the instrument on
- => Connect the instrument to the installation using the measuring cable terminated by a mains plug,
- or
- => Use the separate cables to make the connection.

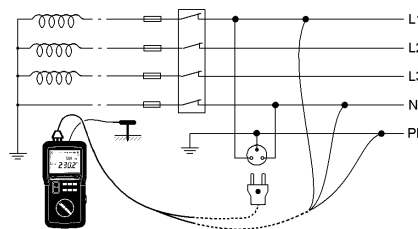

4.1.3 MEASUREMENT PROCEDURE

Once connected, the instrument indicates any voltage(s) present on its terminals.

⚠ Do not use the instrument on an electrical installation exceeding 550 V with respect to earth

4.1.4 MEASUREMENT RESULTS

The measured values and complementary results can be consulted directly using the **▶** and **MORE** Keys, whatever the setting of the switch.

Parameters accessible in the 3P:

| | Initial display | MORE (1 st press) | MORE (2 nd press) |
|-----------------|-----------------|--|--|
| Initial display | Hz U_{HE} | $R_{E\ ALARM}$ ----- | $R_{\Delta E}$ U_L |
| ▶ | Hz U_{SE} | $R_{E\ ALARM}$ ----- | $R_{\Delta E}$ U_L |



Pressing the **MORE** or **▶** key once more returns to the initial display.

Parameters accessible in the 2P:

| | Initial display | MORE (1 st press) | MORE (2 nd press) |
|-----------------|-----------------|--|--|
| Initial display | Hz U_{HE} | $R_{E\ ALARM}$ ----- | $R_{\Delta E}$ U_L |



Pressing the **MORE** key once more causes a return to the initial display.

Parameters accessible in the REarth setting:

| | Initial display | MORE (1 st press) | MORE (2 nd press) |
|---|-----------------|--|--|
| Initial display | Hz ULN | RA ALARM ---- | RA L UL |
|  (1 st press) | Hz ULPE | RA ALARM ---- | RAPE UL |
|  (2 nd press) | Hz UNPE | RA ALARM ---- | RAN UL |
|  (3 rd press) | Hz UP | RA ALARM ---- | ---- UL |



Pressing the  or **MORE** key once more returns to the initial display.

Parameters accessible in the ZLoop setting:

| | Initial display | MORE (1 st press) | MORE (2 nd press) |
|---|-----------------|--|--|
| Initial display | Hz ULN | UREF ZL ALARM | RA L UL |
|  (1 st press) | Hz ULPE | UREF ZL ALARM | RAPE UL |
|  (2 nd press) | Hz UNPE | UREF ZL ALARM | RAN UL |





Pressing the  or **MORE** key once more returns to the initial display.



Parameters accessible in the ZLine setting:

| | Initial display | MORE (1 st press) | MORE (2 nd press) |
|---|-----------------|--|--|
| Initial display | Hz ULN | UREF ZL ALARM | RA L UL |
|  (1 st press) | Hz ULPE | UREF ZL ALARM | RAPE UL |
|  (2 nd press) | Hz UNPE | UREF ZL ALARM | RAN UL |

Pressing the  or **MORE** key once more returns to the initial display.



Parameters accessible in the current measurement  setting:

| | Initial display |  (1 st press) |  (2 nd press) |
|---|-----------------|--|--|
| Initial display | Hz I | Hz ULN | ---- IALARM |
|  (1 st press) | Hz I | Hz ULPE | ---- IALARM |
|  (2 nd press) | Hz I | Hz UNPE | ---- IALARM |

Pressing the  or  key once more returns to the initial display.

4.1.5 CHARACTERISTICS

4.1.5.1 Measurement ranges and accuracy

Frequency :  the value displayed is guaranteed only for a voltage ≥ 10 VRMS (all settings of the switch except  or, in the  position, for a current ≥ 100 mARMS











| | | | | |
|--|-------------------------------------|---|--------------------|-------------------------|
| Voltage measurements Measurements of the potential of the voltage probe | Display range | 400 V | | 4000 V |
| | Specified measurement domain | 2.0 - 79.9 V | 80.0 - 399.9 V | 400 - 550 V (DC or RMS) |
| | Accuracy | $\pm 4\% \pm 5$ pt | $\pm 2\% \pm 1$ pt | $\pm 2\% \pm 1$ pt |
| | Input impedance | 440 k Ω | | |
| | Operating frequency | DC and 15.3 à 450 Hz | | |
| Contact voltage measurement | Specified measurement domain | 2.0 – 100.0 V | | |
| | Accuracy | $\pm 15\% \pm 2$ pt (45Hz < freq. < 65Hz) | | |
| | Input impedance | 4.5 M Ω in series with 4.7 nF | | |
| | Operating frequency | 15.3 to 65 Hz | | |
| Frequency measurement | Display range | 400 Hz | | 4000 Hz |
| | Specified measurement domain | 15.3 – 399.9 Hz | | 400 – 450 Hz |
| | Resolution | 0.1 Hz | | 1 Hz |
| | Accuracy | $\pm 0.1\% \pm 1$ pt | | |

4.1.5.2 Influencing conditions

| Influencing quantities | Limits of the domain of use | Variation of the measurement | |
|-------------------------------------|-----------------------------|------------------------------|-----------------|
| | | Typical | Maximum |
| Temperature | -10 to +55 °C | 1 %/10 °C ± 1pt | 2 %/10 °C + 2pt |
| Relative humidity | 10 to 85 % HR at 45 °C | 2 % | 3 % + 2 pt |
| Power supply voltage | 6.8 to 10 V | 1 % / V + 1pt | 2% / V + 2pt |
| Frequency | 15.3 to 450Hz | 0.5% | 1% |
| Series mode rejection in AC | 0 to 500 V DC | 50dB | 40dB |
| 50/60Hz series mode rejection in DC | | | |
| Common mode rejection in 50/60Hz AC | | | |

4.1.6 WARNINGS OR ERROR REPORTS

Preliminary remark: The complete list of coded errors is given in § 7.

| Display - Indication | Remark - Possible cause(s) |
|--|--|
|  Hz > 550V | One of the voltages measured (U_{LN} , U_{LPE} , or U_{NPE}) is > 550V. |
|  <15.3Hz (or) >65Hz or 450Hz U_{LN} (or) U_{NPE} (or) U_{LPE} | Frequency outside measurement domain (depends on type of measurement) |
|  Hz U_{LN} | N and PE reversed N not connected N not connected and L and PE reversed |
|  Er08 n PE | In ZLINE position : Permutation, PE-L-N instead of L-N-PE |
|  HZ $U_{NPE} > 25$ (or) 50V | L and PE reversed Permutation, N-PE-L instead of L-N-PE |
|  Er02 L | In ZLINE position : L and PE reversed Permutation, N-PE-L instead of L-N-PE |
|  Er03 L | L not connected L not connected and N and PE reversed |
|  Hz $U_{NPE} > 25$ (or) 50V | $U_{NPE} > U_L$ (threshold voltage) |
|  Hz U_{HE} (or) $U_{SE} > 30V$ | In 2P or 3P position: One of the voltages is > maximum allowed spurious voltage. |
|  Hz $U_C > 25$ (or) 50V | In ZLOOP or REARTH position : Potential difference between the local earth and PE too high |

Press the **TEST** key to exit from the error conditions.

4.2 2P AND 3P EARTH MEASUREMENT

4.2.1 DESCRIPTION OF THE FUNCTION

3P and 2P earth measurements are made in a power-off condition. The measurements are made with two auxiliary rods (3 poles) and one auxiliary rod (2 poles), respectively. Note however that measurements with 2 auxiliary rods are more accurate.

Measurement in 3P mode: the instrument generates an alternating current square wave (128 Hz) between terminals H and E, then measures the voltage between terminals S and E: from this voltage and the current generated, it deduces global earthing resistance R_E .

Measurement in 2P mode: the instrument generates a signal between terminals H and E, measures the voltage on terminal H, and deduces resistance R_E .

4.2.2 PREPARATION FOR THE MEASUREMENT (CONNECTION)

- => In SET-UP, set the value of the no-load voltage generated by the instrument: $U_L = 50\text{ V}$, or 25 V in a damp environment (see § 3.2).
- => If necessary,
 - adjust the alarm, $R_{E\text{ALARM}}$, in the SET-UP mode,

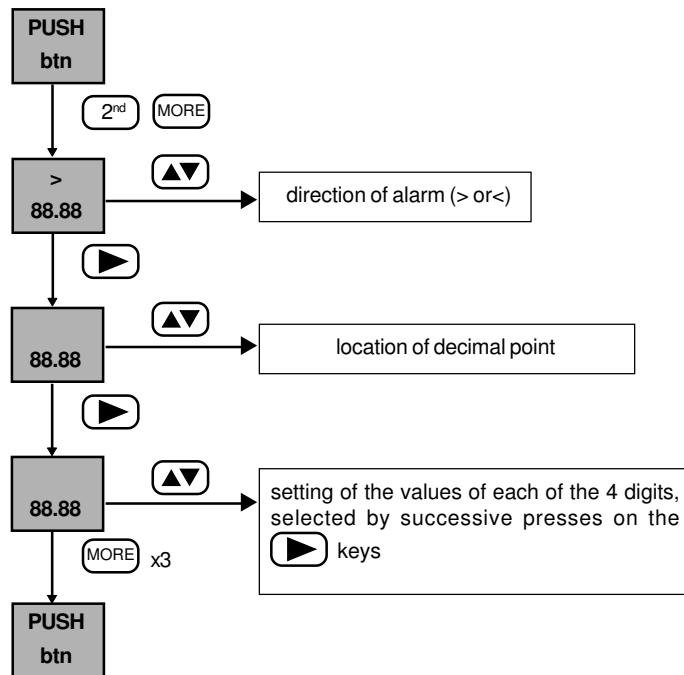

- activate the alarm by pressing the **ALARM** key and 2nd key after SET-UP exit . An overshoot of an alarm threshold during a measurement is indicated by a continuous audible signal
- compensate the measuring cables (see § 3.3).

- => Cut off power to the installation and disconnect the earth of the installation
- => Set the switch to 2P or 3P.
- => Then connect the measuring cables to the instrument and to the rods, complying with the following distances and connections (example of connection for 3P measurement).

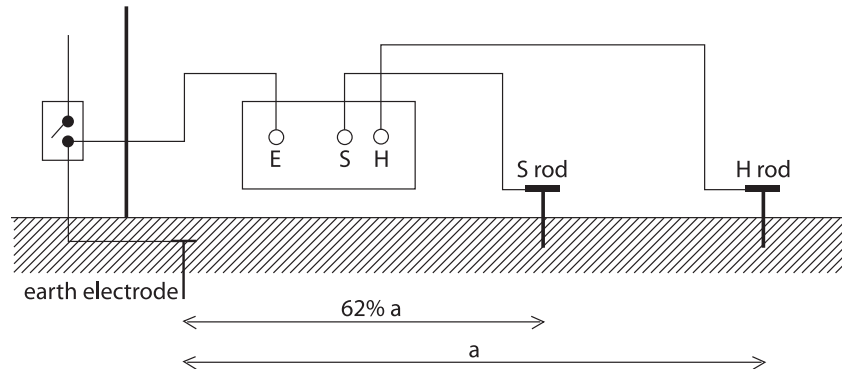

Remark : to be sure that rod S is located in a zone that is not influenced by other earth electrodes, move it (10% of the distance and repeat the measurement. The result must not change or just from few %.

4.2.3 MEASUREMENT PROCEDURE

Press the **TEST** key. The instrument measures voltages U_{HE} and U_{SE} . If the measurement is possible, the instrument checks the resistances of rods S and H: if they are correct, the instrument makes the measurement and displays it.

To make a 2P measurement, plant a single rod and connect the measuring cables to terminals H and E of the instrument. The measurement proceeds in the same way as a 3P measurement.

4.2.4 MEASUREMENT RESULTS

After the measurement, the measured values and complementary results can be consulted using the  and **(MORE)** keys.





(The quantities accessible before the measurement is made are described in § 4.1.4)



Parameters accessible in the 2P setting :

| | Initial display | (MORE) (1 st press) | (MORE) (2 nd press) | (MORE) (3 rd press) |
|-----------------|-----------------|--|--|--|
| Initial display | R_H R_E | H_z U_{HE} | $R_{E\ ALARM}$ ----- | R_{AE} U_L |

Pressing the **(MORE)** key once more causes a return to the initial display.

Parameters accessible in the 3P setting :

| | Initial display |  (1 st press) |  (2 nd press) |  (3 rd press) |
|---|----------------------------------|---|--|---|
| Initial display | R _H R _E | H _Z U _{HF} | R _{E ALARM} ----- | R _{ΔE} U _L |
|  | R _S R _E | H _Z U _{SE} | R _{E ALARM} ----- | R _{ΔE} U _L |

Pressing the  or  key once more causes a return to the initial display.

4.2.5 CHARACTERISTICS

4.2.5.1 MEASUREMENT RANGES AND ACCURACY

Particular reference : resistance of auxiliary earths < 100 Ω

conditions : resistance of the cable connected to terminal E of the instrument compensated

The instrument automatically selects one of two ,measurement currents according to the sum of Re and Rh as well as the set voltage limit.

| R_H + R_E ≥ 9 kΩ at 50 V or R_H + R_E ≥ 4.5kΩ at 25 V | | | |
|---|----------------------------|----------------|-----------------|
| Measuring current = 5 mA | | | |
| Display range | 40 Ω | 400 Ω | 4000 Ω |
| Specified measurement domain | 0.50 – 39.99 Ω | 40.0 – 399.9 Ω | 400 – 3999 Ω |
| Accuracy | ± 2% ± 5pt | | ± 2% ± 2pt |
| Measuring current | 5 mA | | |
| Max. acceptable resistance in the current loop | 8 kΩ (50 V) or 4 kΩ (25 V) | | |
| R_H + R_E ≥ 9 kΩ at 50 V or R_H + R_E ≥ 4,5 kΩ at 25 V | | | |
| Measuring current = 500 μA | | | |
| Display range | 400 Ω | 4000 Ω | 40.00 kΩ |
| Specified measurement domain | 0.5 – 399.9 Ω | 400 – 3999 Ω | 4.00 – 39.99 kΩ |
| Accuracy | ± 2% ± 5pt | | ± 2% ± 2 pt |
| Measuring current | 500 μA | | |
| Max. acceptable resistance in the current loop | 45 kΩ | | |



| Common characteristics | |
|--|--------------|
| Maximum acceptable resistance in the voltage loop | 50 kΩ |
| Frequency | 128 Hz |
| No-load voltage | 25 V or 50 V |
| Accuracy of rod resistance measurements | 5% + 5pt |

4.2.5.2 Influencing conditions

| Influencing quantities | Limits of the domain of use | Variation of the measurement | |
|---|---------------------------------|--------------------------------------|------------------------------------|
| | | Typical | Maximum |
| Temperature | -10 to + 55 °C | 1%/10 °C ± 1pt | 2%/10 °C + 2pt |
| Relative humidity | 10 to 85% RH at 45°C | 2% | 3% + 2 pt |
| Power supply voltage | 6.8 to 10 V | 1% / V ± 1pt | 2%/ V + 2pt |
| Voltage in series in the voltage measurement loop (S-E) | 0 to 30 V from 15.3 to 450Hz | Except at 128 ± 16Hz | 0.2%/V + 1 pt |
| Voltage in series in the current injection loop (H-E) | 0 to 30 V from 15.3 to 450Hz | Except at 128 Hz | 0.2%/V + 1 pt |
| Current loop rod resistance (R _H) | 0 to 50kΩ | 0.5%/10kΩ + 0.015% R _H | 1%/10kΩ + 0.015% R _H |
| Voltage loop rod resistance (R _S) | 0 to 50kΩ | 0.5%/10kΩ + 0.015% R _S | 1%/10kΩ + 0.015% R _S |

4.2.6 WARNINGS OR ERROR REPORTS (2P OR 3P EARTH MEASUREMENTS)

Preliminary remark : the complete list of coded errors is given in § 7

| Display - Indication | Remark - Possible cause |
|--|---|
|  <p>Hz (or) U_{HE} OU U_{SE} > 30V</p> | <p>U_{HE} or U_{SE} is > 30V : the measurement is affected. Try to move rods H and S</p> |
|  <p>Er22 COMP</p> | <p>- resistance on rods H or S too high, - or earth resistance too high, - or spurious voltages too high. Check the connections and the auxiliary rods.</p> |

Press the **TEST** key to exit from the error conditions.

If the value of R_E is negative, it means that:

- the rod resistances are too high,
- or the spurious voltages are too high,
- or the compensation of the cables is wrong. It must be done over with the cables actually used (see § 3.3).

4.3 EARTH MEASUREMENT IN LIVE CONDITION (*REARTH*)

4.3.1 DESCRIPTION OF THE FUNCTION





- This measurement is made with a single auxiliary rod (voltage probe) connected to terminal (P), yielding a saving of time with respect to a conventional measurement with 2 auxiliary rods.
- A specific additional current clamp is necessary to make a selective earth measurement.

The instrument automatically detects the connection of the voltage and current probes.

When the **TEST** key is pressed, the instrument:

- checks that the amplitude and frequency of the voltages present are correct,
- checks the resistance of the auxiliary rod,
- interchanges L and N internally if the 2 conductors are reversed in the socket,
- measures the voltage between the **TEST** key and terminal PE,

If these quantities are correct, the instrument generates, according to the user's selection, a high current ("tripping" mode ) or a low current ("non-tripping" mode ) on 30mA RCD or more) between terminals L and PE and measures the voltage drop between terminals P and PE.

- If the user selects measurement without tripping (), the current generated is low : the instrument measures R_A (global earth resistance).

Note : if, during a earth measurement at low current, a earth fault breaker in the circuit still trips, measure the leakage current with the current probe using the "current measurement" function of the instrument, then change the measuring current I_{TEST} (see § 4.2.2) with allowance for this leakage current. Otherwise, short-circuit the circuit-breaker concerned and make the next measurement at high current for greater accuracy.

- If the user has selected measurement with tripping (or if they have connected the current probe to make a selective measurement), the current generated is high (): arrangements may have to be made to prevent the earth fault breaker from tripping (e.g. temporary shunting of the breaker). The instrument measures Z_A (the global earthing impedance), R_A and L_A (the resistive and inductive parts of Z_A).

Remarks:

- If the user selects measurement without tripping () and connects a current probe, the instrument reverts to measurement with tripping and reports the change.
- If the user connects the current probe, it is the current measured by this probe that is used to calculate R_A . The lower this current, the more unstable the measurement is likely to be: in this case, smooth the measurement using the "SMOOTH" function.

4.3.2 PREPARATION FOR THE MEASUREMENT (CONNECTION)

 **The instrument must be connected to the network in a live condition and the earth electrode to be measured must not be disconnected.**

=> If necessary, set, in the SET-UP mode :

- U_L (see § 3.2),

- the current generated for the measurement at low current :

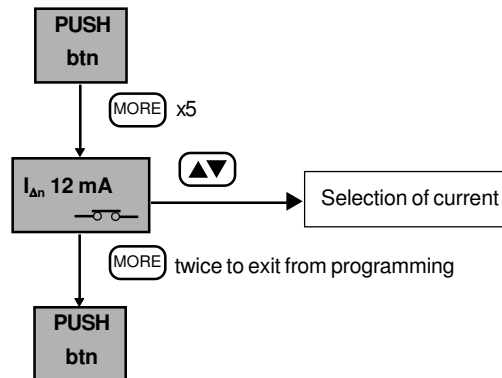

- The type of compensation of the measuring cables (see § 3.3)
- the alarm threshold Z_A or R_A :
- the number of measurements to be counted to smooth the measurement (see § 3.2).

=> Set the switch to the REARTH position,
=> Activate the alarm by pressing the **ALARM** key,

=> Select the measuring current: press (2nd) + (▲)

=> high (—⏏—) for a greater accuracy:

- if there is no tripping of a earth fault breaker (measurement made upstream of the RCDs),
- if the earth fault breaker concerned is short-circuited for greater accuracy,
- in the case of a selective measurement using a current probe.

=> low (—⏏—) for a quick check :

=> Make the connections as indicated below, according to the type of installation to be checked.
=> Compensate the measuring cables (see § 3.3),

Case of an installation with a TT type neutral situation :

=> Connect the mains socket (or the 3 separate cables) to the installation to be tested,

=> Plant the auxiliary rod at a distance > 25 m from the earth electrode.

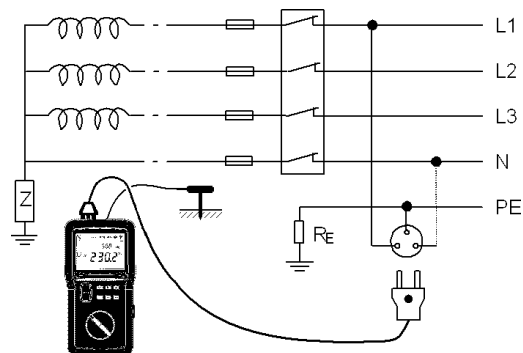

Case of an installation with a TN type neutral situation (selective measurement) :

- => Connect the mains socket (or the 3 separate cables) to the installation to be tested,
- => Connect a current probe to the terminal and encircle the earth of which the resistance is to be measured: the current used to calculate $Z_{A\text{SEL}}$ is that measured by the probe,
- => Plant the auxiliary rod PE as close as possible to the earth electrode to be measured for a measurement that is as accurate as possible,
- => Compensate the cables.

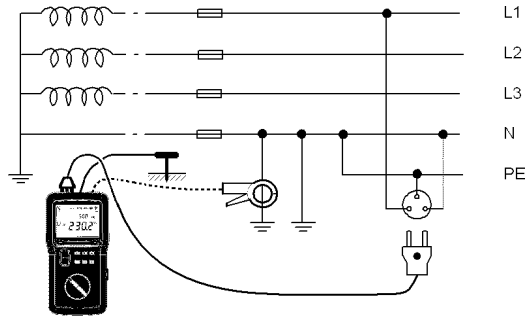

Note : without the current probe, what is measured is the global earth of the network, which is not very significant.

Connecting the clamp configures the instrument in the tripping mode (power-level current).

Case of an installation with an IT type neutral situation (not isolated) :

Preliminary remarks :

- the power supply transformer of the installation must not be completely isolated, but earthed through an impedance,
- **the installation must also not be in first fault: start by checking the indication of the Permanent Insulation Tester concerned,**
- the "grounds to earth" R_A and the earth of the power supply transformer must be separate to allow the circulation of the measuring current.

- => Connect the mains socket (or the 3 separate cables) to the installation to be tested,
- => Plant the auxiliary rod at a distance > 25 m from the earth electrode.

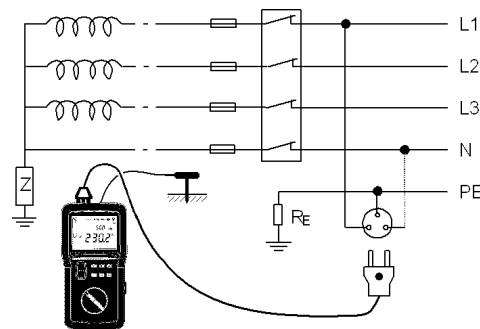

4.3.3 MEASUREMENT PROCEDURE

The instrument first checks the resistance of the rod and measures the voltage between PE and earth, then measures the voltages U_{LN} , U_{LPE} , U_{NPE} .

If these values are correct, pressing the **TEST** key starts the measurement.







Remark : to be sure that the auxiliary rod is located in a zone not influence by other earth electrodes, move the rod (10% of the distance and repeat the measurement. The result must not change. If it does, move the rod until the earth measurement remains unchanged.



4.3.4 MEASUREMENT RESULTS

After the measurement, the measured values and complementary results can be consulted using the **▶** and **MORE** keys.







(The quantities accessible **before** the measurement is made are described above, in § 4.1.4)



Parameters accessible in earth measurement in live condition,  mode (high current):

| | Initial display |  (1 st press) |  (2 nd press) |  (3 rd press) |  (4 th press) |
|---|----------------------------------|--|--|--|--|
| Initial display | R _A Z _A | L _A Z _A | Hz U _{LN} | R _A ALARM U _F | R _{ΔL} U _L |
|  (1 st press) | R _A Z _A | L _A Z _A | Hz U _{LPE} | R _A ALARM U _F | R _{ΔPE} U _L |
|  (2 nd press) | R _A Z _A | L _A Z _A | Hz U _{NPE} | R _A ALARM U _F | R _{ΔN} U _L |
|  (3 rd press) | R _A Z _A | L _A Z _A | Hz U _P | R _A ALARM U _F | R _P U _L |







Pressing the  or  key once more causes a return to the initial display.



Parameters accessible in earth measurement in live condition,  mode (low current):

| | Initial display |  (1 st press) |  (2 nd press) |  (3 rd press) |
|---|------------------------|--|---|--|
| Initial display | R _A ---- | Hz U _{LN} | R _A ALARM U _F | R _{ΔL} U _L |
|  (1 st press) | R _A ---- | Hz U _{LPE} | R _A ALARM U _F | R _{ΔPE} U _L |
|  (2 nd press) | R _A ---- | Hz U _{NPE} | R _A ALARM U _F | R _{ΔN} U _L |
|  (3 rd press) | R _A ---- | Hz U _P | R _A AARM U _F | R _P U _L |

Pressing the  or  key once more causes a return to the initial display.

Parameters accessible in selective earth measurement in live condition,  mode (high current):

| | Initial display |  (1 st press) |  (2 nd press) |  (3 rd press) |  (4 th press) |
|---|--------------------------------------|--|--|--|--|
| Initial display | R _A Z _{A SEL} | ---- I _{SEL} | Hz U _{LN} | R _A ALARM | R _{ΔL} U _L |
|  (1 st press) | R _A Z _{A SEL} | ---- I _{SEL} | Hz U _{LPE} | R _A ALARM | R _{ΔPE} U _L |
|  (2 nd press) | R _A Z _{A SEL} | ---- I _{SEL} | Hz U _{NPE} | R _A ALARM | R _{ΔN} U _L |
|  (3 rd press) | R _A Z _{A SEL} | ---- I _{SEL} | Hz U _P | R _A ALARM | R _P U _L |

Pressing the  or  key once more causes a return to the initial display.

4.3.5 CHARACTERISTICS

4.3.5.1 Measurement ranges and accuracy

Particular reference conditions : nominal voltage of the installation = 90 to 550 V,
 nominal frequency of use = 15.3 to 65 Hz,
 resistance in series with voltage probe: < 100 Ω
 inductive part < 0.1 x the resistive part of the impedance measured,
 resistance of the cable connected to terminal PE corrected,
 contact voltage < 5 V (potential of terminal PE with respect to the local earth).

Characteristics of the measurements:

Characteristics in "high current" mode ("tripping" mode ):

Charge duration : 300µs cycle

| Display range | 40 Ω | | | 400 Ω | 4000 Ω |
|---|----------------|----------------|-----------------|----------------|----------------|
| Specified measurement domain | 0.20 - 1.99 Ω | 2.00 - 19.99 Ω | 20.00 - 39.99 Ω | 40.0 - 399.9 Ω | 400 - 3999 Ω |
| Peak measuring current between 90V and 280V | 1.06 to 3.25 Ω | 0.90 to 3.25 A | 0.79 to 2.83 A | 0.24 to 2.47 A | 0.03 to 0.76 A |
| Peak measuring current between 280V and 550V | 1.27 to 2.73 A | 1.20 to 2.71 A | 1.13 to 2.57 A | 0.55 to 2.42 A | 0.08 to 1.18 A |
| Accuracy of the impedance measurement | ± 10 % ±15 pt | | ± 5 % ±15 pt | ± 5 % ±5 pt | ± 5 % ±2 pt |
| Additional error for Rearth | ± 0.3 Ω | | | | |

Max. inductance acceptable for the measurement : 20 mH (display range 400.0 mH)

Characteristics in "low current" mode ("non-tripping" mode ):

Charge duration : cycle of one network frequency period.

| Display range | 400Ω | | | 4000Ω |
|---|---|--------------|---------------|-------------|
| Specified measurement domain | 0.5 - 1.9Ω | 2.0 - 19.9Ω | 20.0 - 399.9Ω | 400 - 3999Ω |
| RMS measuring current | 6 - 9 - 12 mA (adjustable in «SET-UP» mode : see & 3.2) | | | |
| Accuracy of the resistance measurement⁽²⁾ | ± 15% ± 10 pt | ± 15% ± 5 pt | | |

⁽²⁾ No measurement of the inductive part in "low current" mode.

Characteristic in "selective" mode: Charge duration : 300 μ s cycle

| Display range | 400 Ω | | | 4000 Ω |
|---|---------------------|---------------------|-----------------------|---------------------|
| Specified measurement domain | 0.5 - 1.9 Ω | 2.0 - 19.9 Ω | 20.0 - 399.9 Ω | 400 - 3999 Ω |
| Peak measuring current ⁽³⁾ | ≥ 30 mA | ≥ 10 mA | ≥ 5 mA | ≥ 2 mA |
| Accuracy of the resistance measurement ⁽⁴⁾ | $\pm 15\% \pm 5$ pt | $\pm 10\% \pm 5$ pt | $\pm 15\% \pm 5$ pt | |

⁽³⁾ The measuring current is that measured by the current probe.

⁽⁴⁾ No measurement of the inductive part in "selective" mode.

Characteristics common to all measurement modes:

- **Max. resistance acceptable in series with the voltage probe: 15 k Ω**

- **Accuracy of measurement of the resistance in series with the probe: 20% + 10 pt**













(resolution 0,1 k Ω ; display range 400.0 k Ω)

4.3.5.2 Influencing conditions

| Influencing quantities | Limits of the domain of use | Variation of the measurement | |
|---|----------------------------------|-------------------------------|---------------------------|
| | | Typical | Maximum |
| Temperature | -10 to +55 $^{\circ}$ C | 1%/10 $^{\circ}$ C \pm 1 pt | 2%/10 $^{\circ}$ C + 2 pt |
| Relative humidity | 10 to 85 % HR at 45 $^{\circ}$ C | 2 % | 3 % + 2 pt |
| Power supply voltage | 6.8 to 10 V | 1 % / V + 1pt | 2 % / V + 2 pt |
| Network voltage of the installation tested | 99 to 101 % of nominal frequency | 0.5% | 1 % + 1 pt |
| Network voltage of the installation tested | 85 to 110 % of nominal voltage | 0.5% | 1 % + 1 pt |
| Resistance in series with the voltage probe (earth in live condition only) | 0 to 15 k Ω | 0.1%/k Ω | 0.2 % / k Ω + 1 pt |
| Contact voltage (Uc) | 0 to 50 V | 0.1%/10V | 0.2 % / 10 V |

4.3.6 WARNINGS OR ERROR REPORTS (EARTH MEASUREMENT IN LIVE CONDITION)

Preliminary remark: The complete list of coded errors is given in § 7.

| Indication | Cause possible |
|---|---|
|  Hz $U_c > 25$ (or) 50V | Voltage $> U_L$ between the TEST key and PE: the measurement is disabled. |
|  Hz <90 V | One of the voltages, U_{LN} or U_{LPE} is < 90 V : the measurement is impossible. |
|  Hz $U_{NPE} > 25$ (or) 50V | U_{NPE} is AC and $> U_L$: the measurement is impossible. |
|  < 15.3 Hz (or) > 65Hz U_{LN} (or) U_{NPE} (or) U_{LPE} | The frequency of U_{LN} , U_{LPE} , or U_{NPE} is $< 15,3$ Hz or > 65 Hz : the measurement is impossible. |
|  NO rOd | The rod is not connected, the measurement is stopped. |
|  Er10 $U_p > 50V$ (or) 25V | $U_p > U_L$: the measurement is disabled. |
|  $R_p > 15k\Omega$ U_p | Resistance of the auxiliary rod too high: the measurement is stopped. |
|   | Connection of a current probe after selection of measurement without tripping: the instrument automatically reverts to measurement with tripping and reports the fact. |
|  Er04 $U_f > 50V$ (or) 25V | During the measurement, U_f exceeds the value set in the SET-UP mode: the measurement is stopped. |
|  Er05 | During a selective measurement, the product of the current measured by the current probe and the measured voltage is too low: the measurement is stopped. |
|  Er06 I = ---- | During a selective measurement, the current measured by the current probe is too unstable: the measurement is stopped. |
|  >80°C HOT | The temperature of the instrument is too high: the measurement is stopped. Pressing the TEST key has no effect until the temperature of the instrument is again below 60°C; another measurement can then be started. |

Press the **TEST** key to exit from the error conditions.

4.4 WIRE LOOP MEASUREMENT (Z LOOP)

4.4.1 DESCRIPTION OF THE FUNCTION

In a TT network, measurement of loop impedance LPE is a rapid and practical way of **checking a earth resistance without planting auxiliary rods**. In this case, the measurement includes the earthing resistance of the power supply transformer of the installation and the resistance of the distribution cables. It is therefore a high earth measurement, and any error is on the safe side.

In TT and TN networks, this function can also be used to check and size the protective systems in place by a rapid and easy measurement of the loop impedances between L and PE, L and N, and N and PE. This function can also be used to calculate the corresponding short-circuit currents (sizing of fuses and circuit breakers).

Note that the instrument allows measurement of loop impedance LPE behind 30mA circuit-breakers without causing them to trip (principle patented by Chauvin Arnoux).

In an IT network, use the instrument's "ZLINE" function.

The measurement principle is the same as for an earth measurement in a live condition.

When the **TEST** key is pressed, the instrument :

- checks that the amplitude and frequency of the voltages present are correct,
- measures the voltage between the **TEST** key and terminal PE,
- interchanges L and N internally if the 2 conductors are reversed in the socket,
- generates a current (high or low according to the user's selection) between terminals L and PE,
- measures loop impedances Z_{LN} , Z_{LPE} , et Z_{NPE} .

Note: the measurement of Z_{LN} does not trip the earth fault breakers even with high currents.

4.4.2 PREPARATION FOR THE MEASUREMENT (CONNECTION)

=> If necessary, in SET-UP mode:

- set threshold voltage U_L (see § 3.2),
- the type of compensation of the measuring cables (see § 3.3))
- set the alarm threshold Z_L or R_L (see § 4.2.2)
- possibly, select a value of U_{REF} to be used for the calculation of the short-circuit current :

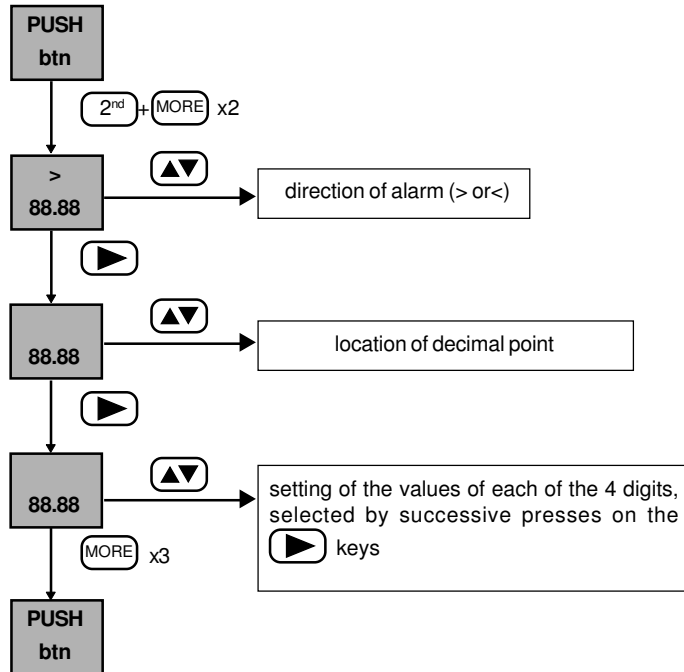

- possibly, select a value of U_{REF} to be used for the calculation of the short-circuit current:

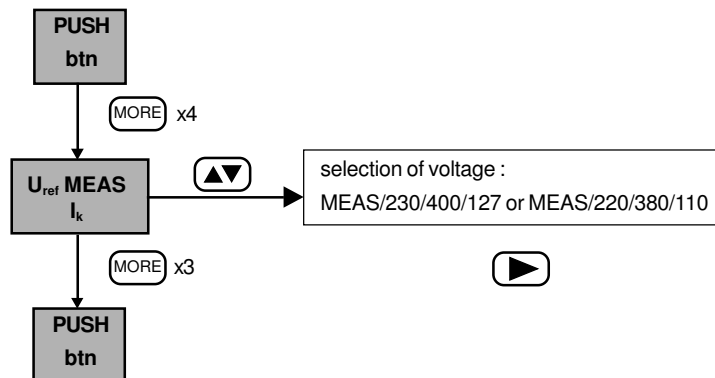



- the current generated for the measurement in low current mode (see § 4.2.2),
- set the number of measurements to be counted to smooth the measurement (see § 3.2)

=> Set the switch to the ZLOOP position,

=> Activate the alarm by pressing the **ALARM** key,

=> Connect the line power plug or the 3 separate cables to the installation to be tested,

- => Compensate the measuring cables (see § 3.3),
- => Select the measuring current: press **(2nd)** + **(▲)**
 - => high () for a greater accuracy:
 - if no tripping of a earth fault breaker is foreseen (measurement made upstream of the RCDs),
 - if the earth fault breaker concerned is short-circuited for greater accuracy,
 - => low () otherwise for a rapid check

The connection diagrams are the same as for earth measurements in a live condition, but without the voltage or current probe (see § 4.2.2).

4.4.3 MEASUREMENT PROCEDURE

The instrument first checks the resistance of the rod and measures the voltage between PE and earth, then measures voltages U_{LN} , U_{LPE} , U_{NPE} .

If these values are correct, pressing the **TEST** key starts the measurement: as soon as the result is available, it is displayed.

Note: for measurements on three-phase systems, the loop impedance must be measured between each phase conductor, the neutral conductor, and the protective conductor.

4.4.4 MEASUREMENT RESULTS

After the measurement, the measured values and complementary results can be consulted using the **(▶)** and **(MORE)** keys.

(The quantities accessible **before** the measurement is made are described above, in § 4.1.4.)

| | Initial display | (MORE) (1 st press) | (MORE) (2 nd press) | (MORE) (3 rd press) | (MORE) (4 nd press) | (MORE) (5 nd press) |
|------------------------------------|------------------------|--|--|--|--|--|
| Initial display | R_{LPE} Z_{LPE} | L_{LPE} Z_{LPE} | U_{REF} I_{KLPE} | Hz U_{LPE} | ---- Z_L ALARM | R_{APE} U_L |
| (▶) (1 st press) | R_{LN} Z_{LN} | L_{LN} Z_{LN} | U_{REF} I_{KLN} | Hz U_{LN} | ---- Z_L ALARM | R_{AL} U_L |
| (▶) (2 nd press) | R_{NPE} Z_{NPE} | L_{NPE} Z_{NPE} | U_{REF} I_{KNPE} | Hz U_{NPE} | ---- Z_L ALARM | R_{AN} U_L |

Pressing the **(▶)** or **(MORE)** key once more causes a return to the initial display.



Note : In non-trip mode the inductive component is not measurable due to the weak test current. The values L_{LPE} , L_{NPE} , Z_{NPE} , are not displayed (display shows - - - -). The value L_{LPE} is displayed in the L_{LN} field.

4.4.5 CHARACTERISTICS

4.4.5.1 Measurement ranges and accuracy

Particular reference conditions :

- nominal voltage of the installation = 90 to 550V,
- nominal frequency of use = 15.3 to 65Hz,
- inductive part < 0.1 x the resistive part of the impedance measured.

The characteristics of loop measurements with 3 wires, with () or without tripping () are the same as those of earth measurements in a live condition, with or without tripping, respectively: see § 4.3.5.1.

Characteristics of calculation of short-circuit current I_k :

| | | | |
|----------------------------|---|--------|-------|
| Display range | 400 A | 4000 A | 40 kA |
| Resolution | 0.1 A | 1 A | 10 A |
| Accuracy | Resistances, impedances : Accuracy values indicated for earth measurements in a live condition (see § 4.2.5) Short-circuit current : Accuracy of impedances + accuracy of measurement of voltage U_{mes} , if it is used | | |
| Calculation formula | $I_k = U_{REF} / Z_{LOOP}$ (OU Z_{LINE}) | | |

4.4.5.2 Influencing quantities

Same as for earth measurements in a live condition (cf. § 4.3.5.2)

4.4.6 WARNINGS OR ERROR REPORTS (ZLOOP LOOP MEASUREMENTS)

Preliminary remark : The complete list of coded errors is given in § 7.

Same as for earth measurements in a live condition, except for the rod and the current probe measurement, which do not apply to loop measurements: see § 4.3.6.

4.5 WIRE LOOP MEASUREMENT (Z LINE)

4.5.1 DESCRIPTION OF THE FUNCTION

This function measures the line impedance between conductors "L" and "N" of the power network. This measurement can also be used to calculate short-circuit currents, in order to size fuses and circuit breakers.

It is possible to check the impedance between conductors "L" and "PE" or between two "L" conductors, but the measuring cables must systematically be connected to terminals "L" and "N" of the measuring instrument.

4.5.2 PREPARATION FOR THE MEASUREMENT (CONNECTION)

- => If necessary, in SET-UP mode :
 - set the threshold voltage U_L (see § 3.2),
 - set the alarm threshold Z_L ou R_L (see § 4.4.2),
 - choose the value of U_{REF} to be used to calculate short-circuit currents (see § 4.4.2)

=> Set the switch to ZLINE,

=> Connect the line power plug (or 2 separate cables) to the installation to be tested.

=> Activate the alarm by pressing the **ALARM** key,

=> Compensate of the measuring cables (see § 3.3)

The connection diagrams are the same as for earth measurements in a live condition, but without the voltage or current probe or the connection to terminal PE (if this connection is made, it is not taken into account) : see § 4.3.2.

4.5.3 MEASUREMENT PROCEDURE

 **In the case of 2-wire loop measurements, there is no monitoring of the potential of terminal PE nor the installation PE line.**

Loop measurements with 2 wires are identical to loop measurements with 3 wires except as follows :

- the voltage between the **TEST** key and PE is not measured: only the potential between terminals L and N is measured;
- there is no monitoring of U_{NPE} which enable the measurement.







The instrument measures voltage U_{LN} and voltages U_{LPE} , U_{NPE} if terminal PE is connected.

Nota : pour les mesures dans les systèmes triphasés, cette impédance doit être mesurée entre chaque conducteur de phase et le conducteur du neutre.

4.5.4 MEASUREMENT RESULTS

After the measurement, the measured values and complementary results can be consulted using the  and **MORE** keys.

(The quantities accessible **before** the measurement is made are described above, in § 4.1.4.)

| | Initial display |  (1 st press) |  (2 nd press) |  (3 rd press) |  (4 nd press) |  (5 nd press) |
|---|----------------------|--|--|--|--|--|
| Initial display | R_{LN} Z_{LN} | L_{LN} Z_{LN} | U_{REF} I_{KLN} | Hz U_{LN} | ---- Z_L ALARM | R_{Δ} U_L |
|  (1 st press) | R_{LN} Z_{LN} | L_{LN} Z_{LN} | U_{REF} I_{KLN} | Hz U_{LPE} | ---- Z_L ALARM | R_{Δ} U_L |
|  (2 nd press) | R_{LN} Z_{LN} | L_{LN} Z_{LN} | U_{REF} I_{KLN} | Hz U_{NPE} | ---- Z_L ALARM | R_{Δ} U_L |

Pressing the  or **MORE** key once more causes a return to the initial display.

4.5.5 CHARACTERISTICS

4.5.5.1 Measurement ranges and accuracy

The particular reference conditions are the same as for 3-wire loop measurements (see § 4.3.5).

The characteristics are the same as for earth measurements in a live condition: see § 4.2.5.1.

4.5.5.2 Influencing quantities

Same as for earth measurements in a live condition: see § 4.2.5.2.

4.5.6 WARNINGS OR ERROR REPORTS

Same as for earth measurements in a live condition (see § 4.2.6) except as follows:

- the rod and the current probe are not taken into account,
- error management on U_{LN} only,
- measurement between the **TEST** key and PE not taken into account.

4.6 CURRENT MEASUREMENT (🔌)

4.6.1 DESCRIPTION OF THE FUNCTION

In the 🔌 position, the instrument measures the alternating current continuously, without the **TEST** key being pressed.

The instrument deduces the current flowing in the cable(s) clamped by the probe according to the transformation ratio of the probe.

4.6.2 PREPARATION OF THE MEASUREMENT (CONNECTION)

=> Connect the clamp to the measuring instrument (specific triple socket designed to avoid connection errors)

=> Set the switch to 🔌,

=> Clamp the cable of which the current is to be measured.

=> If necessary, in the SET-UP mode, set alarm threshold I_{ALARM}

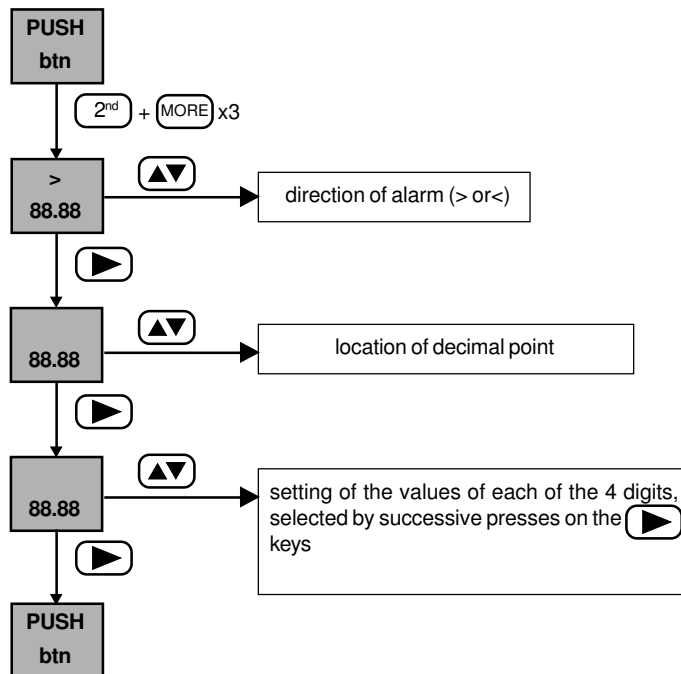

=> If necessary, activate alarm threshold I_{ALARM} by pressing the **ALARM** key.

4.6.3 MEASUREMENT PROCEDURE

The measurement is started automatically and is continuous.

4.6.4 MEASUREMENT RESULTS

The measured values and complementary calculated results are described in the table of § 4.1.4 (position 🔌 of the switch).

4.6.5 CHARACTERISTICS

4.6.5.1 Measurement ranges and accuracy

Particular reference conditions :

- peak factor = 1.414,
- DC component < 0.1 %,
- operating frequency domain = 15.3 to 450 Hz.

Characteristics with an MN 20 current probe :

| | | | |
|-------------------------------------|----------------|-----------------|----------------|
| Display range | 400 mA | 4 A | 40 A |
| Specified measurement domain | 5.0 - 399.9 mA | 0.400 - 3.999 A | 4.00 - 20.00 A |
| Accuracy | 2 % + 10 pt | 1.5 % + 2 pt | 1.2 % + 2 pt |

Note : in measurement of I_{SEL} , the accuracy is increased by 5 %.

Characteristics with an C172 current probe :

| | | | |
|-------------------------------------|----------------|-----------------|----------------|
| Display range | 400 mA | 4 A | 40 A |
| Specified measurement domain | 5.0 - 399.9 mA | 0.400 - 3.999 A | 4.00 - 20.00 A |
| Accuracy | 2 % + 10 pt | 1.5 % + 2 pt | 1.2 % + 2 pt |

4.6.5.2 Influencing conditions

| Influencing quantities | Limits of the domain of use | Variation of the measurement | |
|---|-----------------------------|------------------------------|------------------|
| | | Typical | Maximum |
| Température | -10 to + 55 °C | 1 %/10 °C ± 1 pt | 2 %/10 °C + 2 pt |
| Relative humidity | 10 à 85 % HR at 45 °C | 2 % | 3 % + 2 pt |
| Power supply voltage | 6.8 to 10 V | 1 % / V + 1 pt | 2 % / V + 2 pt |
| Frequency (without the current probe) | 15.3 to 450 Hz | 0.5 % | 1 % |
| Common mode rejection in AC 50/60Hz en DC | 0 to 500 V AC | 50 dB | 40 dB |

4.6.6 WARNINGS OR ERROR REPORTS (🔔)

Preliminary remark: The complete list of coded errors is given in § 7.

| Display - Indication | Remark - cause |
|--|---|
|  Er18 Prob | The clamp is not connected: the measurement is impossible |

Press the **TEST** key to exit from the error conditions.

5. GLOSSARY

| | |
|--|---|
| Hz | : frequency of the signal |
| I | : current |
| I_{ALARM} | : current threshold |
| I_{KLN} ; I_{KLPE} ; I_{KNPE} | : short-circuit current between terminals L and N, L and PE, N and PE |
| I_{SEL} | : current flowing in the current probe during a selective earth measurement in a live condition. |
| L_E | : inductive part of Z_E |
| L_{LN} ; L_{LPE} ; L_{NPE} | : inductive part of impedance Z_{LN} , Z_{LPE} , Z_{NPE} |
| R_A | : global compensation between 2 terminals (2P and ZLine) |
| R_{AE} | : compensation of the cable in terminal E |
| R_{AL} | : compensation of the cable in terminal L |
| R_{AN} | : compensation of the cable in terminal N |
| R_{APE} | : compensation of the cable in terminal PE |
| R_E | : global earthing resistance |
| R_A | : earth resistance in earth measurement on live circuit |
| R_{A SEL} | : selective earth resistance |
| R_{A ALARM} | : earth resistance alarm threshold |
| R_{E ALARM} | : alarm threshold for earth resistance measurements |
| R_H | : resistance of the auxiliary earth electrode (resistance of an additional earth electrode, necessary for the measurements, through which the current flows : standard NF EN 61557) |
| R_{L ALARM} | : sloop resistance threshold |
| R_{LN} ; R_{LPE} ; R_{NPE} | : real part of impedance Z_{LN} , Z_{LPE} , Z_{NPE} |
| R_P | : resistance of the auxiliary rod in a earth measurement in a live condition |
| R_S | : resistance of the auxiliary rod S (resistance of an additional earth electrode used as a probe, used to tap the potential during the measurements : standard NF EN 61557) |
| U_F | : fault voltage as per standard NF EN 61557 |
| U_{HE} | : voltage between terminals H and E |
| U_L | : conventional limit contact voltage: 25 or 50 V, adjustable in the "SET-UP" mode (see § 3.2) |
| U_{LN} | : voltage between terminals L and N |
| U_{LPE} | : voltage between terminals L and PE |
| U_{NPE} | : voltage between terminals N and PE |
| U_P | : voltage between the voltage probe / auxiliary rod and PE |
| U_{REF} | : reference voltage for calculation of the short-circuit current |
| U_{SE} | : voltage between terminals S and E |
| Z_E | : global earthing impedance |
| Z_{LN} ; Z_{LPE} ; Z_{NPE} | : impedance of the loop between L and N, between L and PE and between N and PE |
| Z_{L ALARM} | : loop impedance threshold |

6. MAINTENANCE

6.1 REPLACING THE BATTERIES

The remaining battery charge level is indicated by the symbol .

When the battery is flat (the symbol  flashes), the instrument emits an audible stop signal (5 beeps), then automatically switches to standby. When the battery is low, display of the "BAtt" message indicates that the measurement requested requires too much energy and cannot be made.

Note: when rechargeable batteries are used, this fact must be entered in the configuration of the instrument ("SET-UP" mode) to prevent incorrect operation of the instrument (risk of erroneous measurements or malfunction of the instrument).



Check that none of the input terminals are connected and that the switch is set to OFF before opening the instrument.

When the batteries are removed, there is enough reserve energy to preserve the date and time for one minute. If this time is exceeded, the instrument, when next started up, prompts the user to check the date and time by displaying the flashing message "tIME" for 2 seconds before displaying new measurements.

6.2 STORAGE

If the instrument is to be stored for more than 2 months, remove the batteries. It will then be necessary to reset the instrument's time when it is next used.

6.3 CLEANING

Clean the housing of the instrument regularly. This can be done with a damp cloth or soapy water. Do not use alcohol, solvents, or hydrocarbons.

6.4 METROLOGICAL VERIFICATION

Like all measuring or testing devices, the instrument must be checked regularly.

This instrument should be checked at least once a year. For checking and calibration, contact one of our accredited metrology laboratories (information and contact details available on request), at our Chauvin Arnoux subsidiary or the branch in your country.

6.5 WARRANTY

Unless otherwise stated, our warranty is valid for 12 months following the date on which the equipment is made available (extract from our General Conditions of Sale, available on request).

6.6 CUSTOMER SERVICE



For maintenance work, use only specified spare parts.



The manufacturer cannot be held liable for any accident that occurs following a repair done other than by its Customer Service Department or an approved repairer.

Repair under and out of warranty :

Send the instrument to one of the MANUMESURE regional agencies, approved by Chauvin Arnoux
Information and coordinates on request: Tel.: 02 31 64 51 43 - Fax: 02 31 64 51 09

Repair outside mainland France :

For any repair (under or out of warranty), send the instrument back to the dealer.

6.7 REPAIR

For all repairs before or after expiry of warranty, please return the device to your distributor.

7. LIST OF CODED ERRORS

| Error code | Meaning |
|------------|---|
| Er02 | Incorrect wiring or connection error: L and PE reversed |
| Er03 | Incorrect wiring or connection error: L missing |
| Er04 | U_F voltage too high on earth electrode (danger): measurement STOPPED |
| Er05 | The calculation (current measured by the probe) by (the measured voltage) is too low |
| Er06 | The current measured by the probe is too unstable |
| Er07 | Earth potential too high (potential danger): measurement STOPPED |
| Er08 | Untimely interruption of the current during the measurement of Z_{LN} or Z_{LPE} (earth fault breaker tripped?) - Probable cause: reversal of conductors N and PE or the installation leakage current is too high |
| Er10 | Voltage too high on the voltage probe (danger): measurement STOPPED |
| Er18 | Current probe not connected |
| Er 22 | RH + RE or parasitic voltages are too high in 2P/3P measurement (the voltage exceeds the safety limit in terms of contact voltage). |
| Er24 | Backup memory full (action: delete stored data) |

8. TO ORDER

C.A 6456 earth and loop tester

P01123512

Delivered in a carrying bag containing:

- 1 measuring cable for Euro mains socket,
- 1 measuring cable, 3 separate leads,
- 3 crocodile clips (red, yellow, and white),
- 3 contact pins (red, yellow, and white),
- 1 pouch with neck strap
- 1 optical communication cable
- data processing software program
- 6 LR6 batteries (1.5V)
- 1 user manual

C.A 6456 + T

P01123513

Same as above + a earth kit comprising two rods, three cables on reels, terminated by clips (red, 30m; blue, 30m; green, 10m) and a mallet

ACCESSORIES

- C172 current probe
- MN20 current probe
- serial printer
- Earth kit

P01120310

P01120440

P01102903

P01101823



07 - 2013

Code 689909B02 - Ed. 2

DEUTSCHLAND - Chauvin-Arnoux GmbH
Straßburger Str. 34 - 77694 Kehl / Rhein
Tél : 7851 99 26-0 - Fax : 7851 99 26-60

ESPAÑA - Chauvin-Arnoux Ibérica S.A.
C/ Roger de Flor N°293 - Planta 1 - 08025 BARCELONA
Tél : 902 20 22 26 - Fax : 934 59 14 43

ÖSTERREICH - Chauvin-Arnoux Ges.m.b.H
Slamastrasse 29 / 2 / 4 - 1230 WIEN
Tél : 161 61 961 - Fax : 161 61 961 61

SWEDEN - Chauvin-Arnoux Mätssystem AB
Sjöflygvägen 35 - Box 4501 - 18304 TÄBY
Tél : 850 52 68 00 - Fax : 850 52 68 10

ITALIA - A.M.R.A. SPA
Via Sant' Ambrogio, 23/25
20050 BAREGGIA DI MACHERIO (MI)
Tél : 039 245 75 45 - Fax : 039 481 561

SCHWEIZ - Chauvin-Arnoux AG
Moosacherstrasse 15 - 8804 AU / ZH
Tél : 44 727 75 55 - Fax : 44 727 75 56

LIBAN - Chauvin-Arnoux Middle East
P.O. BOX 60-154 - 1241 2020 JAL EL DIB
Tél : 18 90 425 - Fax : 18 90 424

CHINA - Shanghai Pujiang Enerdis Inst. CO. LTD
3F 3Rd Buildind - N381 Xiang De Road - 200081 - SHANGHAI
Tél : 21 65 21 51 96 - Fax : 21 65 21 61 07

USA - Chauvin-Arnoux Inc - d.b.a AEMC Instruments
200 Foxborough Blvd. - Foxborough - MA 02035
Tél : (508) 698-2115 - Fax : (508) 698-2118

UNITED KINGDOM - Chauvin-Arnoux Ltd
Unit 1 Nelson Court - Flagship Square - Shaw Cross Business
Park - DEWSBURY - 99132 WEST YORSHIRE WF 127TH
Tél : 1 924 460 494 - Fax : 1 924 455 328

<http://www.chauvin-arnoux.com>

190, rue Championnet - 75876 PARIS Cedex 18 - FRANCE
Tél. +33 (0)1 44 85 44 85 - Fax +33 (0)1 46 27 73 89 - info@chauvin-arnoux.fr
Export : Tél. +33 (0)1 44 85 44 38 - Fax +33 (0)1 46 27 95 59 - export@chauvin-arnoux.fr